

## DL15X Low-Frequency Reproducer

- Woofer for two-way speech and music systems
- High excursion for low-frequency clarity and punch
- TIR™ & FDD™ reduce distortion, keep voice coil cool, and smooth frequency response
- 400 watts long-term power capacity
- 101-dB sensitivity
- Thermally efficient magnet assembly for high reliability
- PROTEF™ coating helps protect woofer from excessive power peaks

### SPECIFICATIONS

Usable Axial Frequency Response in Typical Enclosure (4.0 ft<sup>3</sup> tuned to 40 Hz), Swept One-Third-Octave Pink Noise, 4 Volts at 10 Feet, Anechoic Environment, Normalized for 1 Watt/1 Meter (see Figure 1):<sup>1</sup>

45-3,000 Hz

Power Handling (see Power-Handling Test section),

Per ANSI/EIA RS-426-A 1980:

400 watts

Per AES2-1984/ANSI S4.26-1984,

50-500 Hz: 400 watts

100-1,000 Hz: 500 watts

Sensitivity (SPL at 1 m, 1 watt input power, nominal impedance),

200- to 3,000-Hz Average:

101 dB

100- to 800-Hz Average:

98 dB

Impedance Response (see Figure 4 for response in typical enclosure; see Figure 3 for response in standard baffle),

Minimum ( $Z_{min}$ ):

6.5 ohms at 230 Hz

Nominal:

8 ohms

Distortion Response (on axis in standard baffle, 10% rated input power; see Figure 5),

Second Harmonic,

100 Hz: -21 dB (8.9%)

1,000 Hz: -38 dB (1.3%)

Third Harmonic,

100 Hz: -31 dB (2.8%)

1,000 Hz: -40 dB (1.0%)

Beamwidth (angle included by 6-dB-down points on polar responses for octave bands of pink noise; see Figure 6),

500 Hz: 80°

1,000 Hz: 80°

2,000 Hz: 60°

### Physical Constants,

Effective Piston Diameter:

330.0 mm (13.0 in.)

Moving Mass ( $M_{MD}$ ):

0.062 kg (0.137 lb)

Voice-Coil Winding Depth:

15.2 mm (0.6 in.)

Voice-Coil Diameter:

63.5 mm (2.5 in.)

Voice-Coil Winding Length:

18.1 m (59.4 ft)

Top Plate Thickness at Voice Coil:

10.9 mm (0.43 in.)

BL Factor:

20 tesla meter

Thiele-Small Parameters (broken in),

$f_s$ : 42.0 Hz

$V_{AS}$ : 195 liters (6.89 ft<sup>3</sup>)

$Q_{ES}$ : 0.30

$Q_{MS}$ : 4.55

$Q_{TS}$ : 0.28

$R_e$ : 6.0 ohms

$\eta_o$ : 4.63%

$S_D$ : 0.086 m<sup>2</sup> (132 in.<sup>2</sup>)

$M_{MD}$ : 0.062 kg (0.137 lb)

$L_E$ : 1.6 mH

$C_{MS}$ : 0.19 mm/N

$R_{ms}$ : 4.43 mechanical ohms

$P_E(max)$  (per ANSI/EIA RS-426-A 1980):

400 watts

$X_{max}^2$ : 4.1 mm (0.16 in.)

$X_{lim}^3$ : 12.7 mm (0.50 in.)

$V_D (S_D \times X_{max})$ : 3.53 liters (0.012 ft<sup>3</sup>)

Thermal Rise after Power Test:

82 °C (180 °F)

Typical Vented Enclosures (see Typical Enclosures section):

4.0 ft<sup>3</sup> tuned to 40 Hz or 6.0 ft<sup>3</sup> tuned to 35 Hz

- $X_{max}$  is the one-way peak excursion which produces 10% THD of the current waveform when driven at  $f_s$ .
- Displacement limit is the one-way peak excursion which, when exceeded, will cause physical damage to the drive mechanism.

Typical Amplifier Size (see Typical Amplifier Size section):

400-800 watts

Mounting Information (see Mounting section),

Bolt-Hole Diameter

(eight evenly spaced holes):

7.1 mm (0.28 in.)

Bolt Circle Diameter:

371 mm (14.60 in.)

Baffle Opening Diameter

(front or rear mounting):

353 mm (13.90 in.)

Electrical Connections (see Electrical Connectors section),

Connector Type:

Push terminals for bare wires

Polarity:

A positive voltage applied to the positive (red) terminal produces a positive pressure at the front of the cone

Additional Descriptive Information,

Magnet Weight:

2.2 kg (4.9 lb)

Magnet Material:

Barium ferrite

Frame:

Cast aluminum

Frame Finish:

Textured black epoxy

Plating of Steel Parts:

Bright Cadmium

Voice-Coil Material:

Aluminum

Voice-Coil Insulation:

Polyimide 220 °C rating

Voice-Coil Form:

Polyimide

Back Cover:

Black, advanced synthetic elastomer

Optional Accessories:

SMH-1 mounting hardware kit

1. For swept-sine-wave response in standard baffle, per AES2-1984/ANSI S4.26-1984, see Figure 2.

DL15X SPECIFICATION GRAPHICS

FIGURE 1 — Axial Response in Typical Enclosure (4.0 ft<sup>3</sup>), 1 Watt/1 Meter

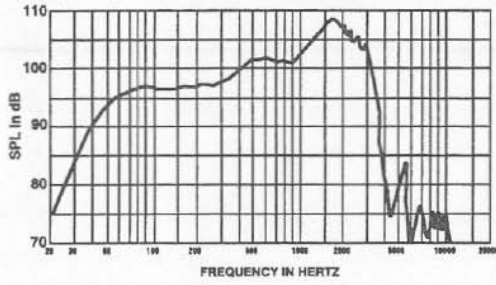

FIGURE 2 — Frequency Response in Standard Baffle (0° and 45°)

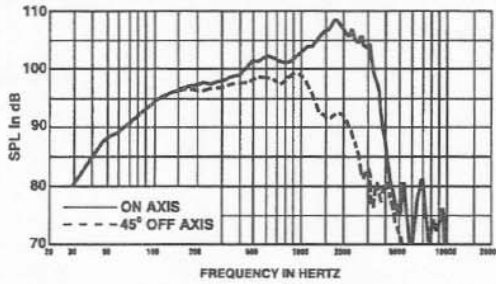

FIGURE 3 — Impedance in Standard Baffle

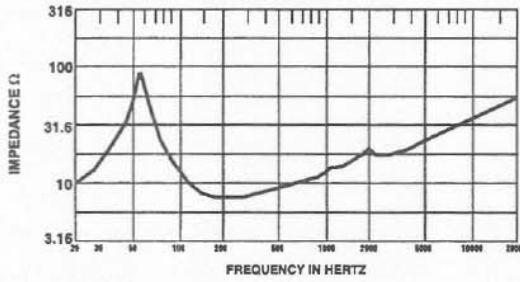

FIGURE 4 — Impedance in Typical Enclosure (4.0 ft<sup>3</sup>)

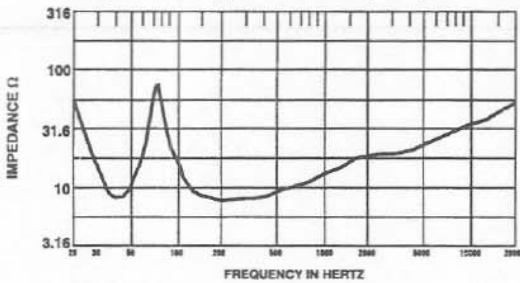

FIGURE 5 — Dimensions

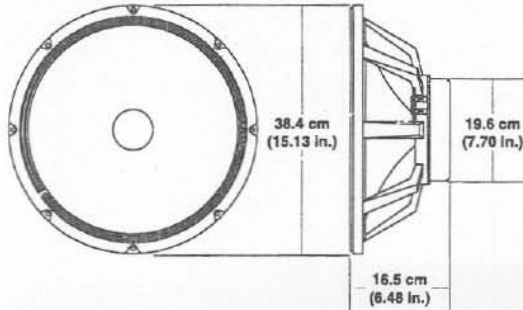

FIGURE 6 — Distortion in Standard Baffle at 10% Rated Input Power

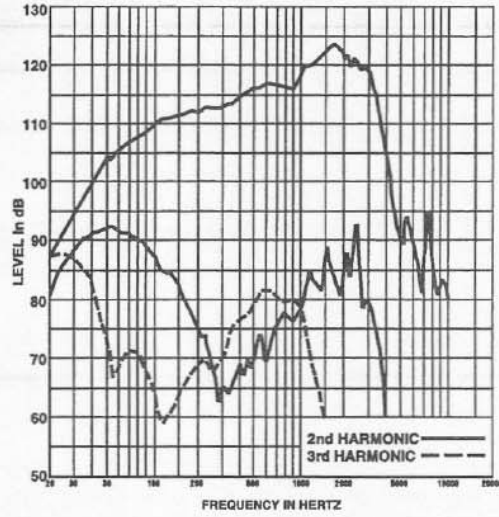

FIGURE 7 — Beamwidth vs. Frequency

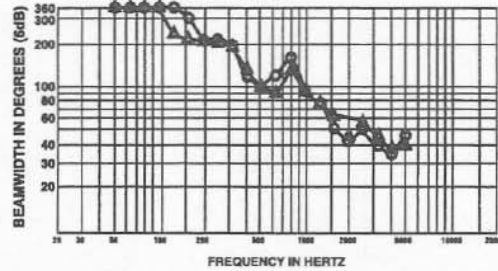

FIGURE 8 — Directivity vs. Frequency

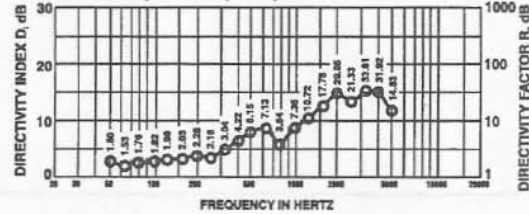
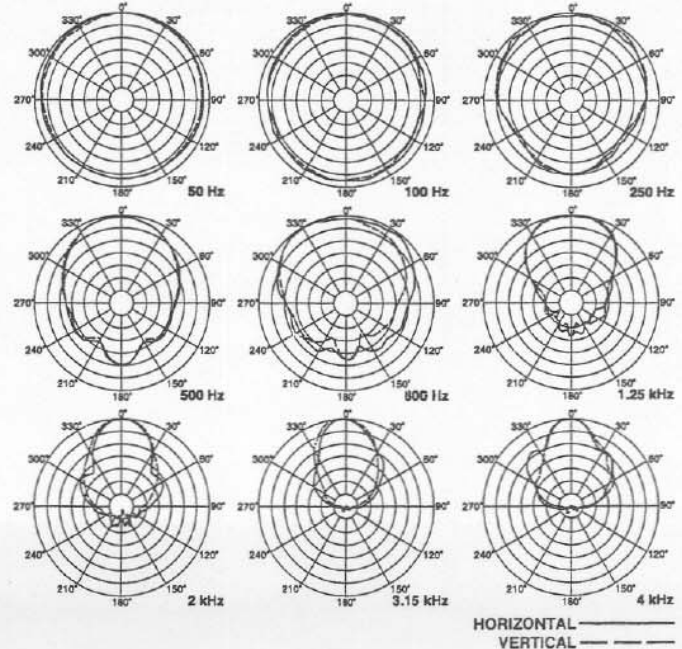
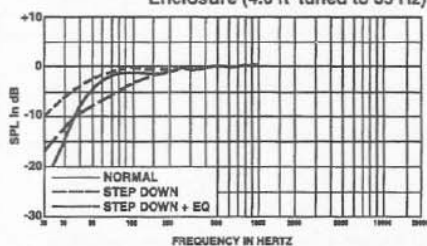

FIGURE 9 — Polar Response



**FIGURE 10A** — Predicted Low-Frequency Response in a Typical Enclosure (4.0 ft<sup>3</sup> tuned to 35 Hz)



**FIGURE 10B** — Predicted Low-Frequency Response in a Typical Enclosure (6.0 ft<sup>3</sup> tuned to 30 Hz)

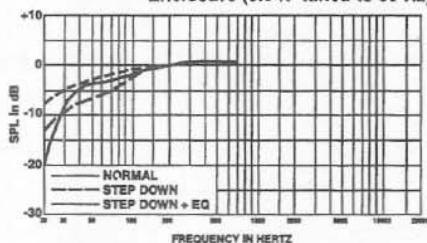

**FIGURE 11** — Maximum SPL at 1 Meter in Typical Enclosure (4.0 ft<sup>3</sup> tuned to 35 Hz)

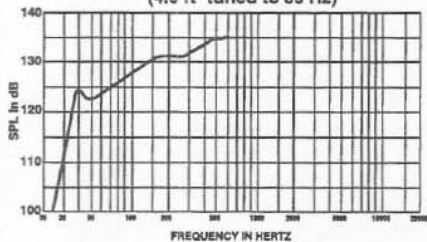

#### Dimensions (see Figure 10),

- Outer Diameter:  
384 mm (15.13 in.)
- Overall Depth:  
165 mm (6.48 in.)

#### Net Weight:

8.6 kg (19.0 lb)

#### Shipping Weight:

10.2 kg (22.5 lb)

#### DESCRIPTION

The DL15X low/mid-frequency reproducer is a 15-inch, 8-ohm driver designed for professional high-level, high-fidelity monitoring and sound reinforcement. At the heart of this speaker is a carefully engineered drive system. Its design assures linear, low-distortion output, high power capability and efficient heat transfer.

Incorporated into the design are three exclusive Electro-Voice innovations. PROTEF™ coating (U.S. patent #4,547,632), a Teflon®-based coating, is applied to the inside diameter of the top plate.<sup>4</sup> Occasional violent power peaks of several seconds may expand a transducer's voice coil into contact with the top plate, causing failure. PROTEF provides protection against such failure. The coating lubricates any rubbing contact and provides electrical insulation between the coil and the steel top plate. The Thermo Inductive Ring (TIR™) and Flux Demodulation Device (FDD™), also included in the DL15X design, are aluminum castings fastened to the pole of the magnet. They pro-

vide a shorted turn to control inductance and provide a major heat transfer path from the voice coil, which improves power handling and reduces thermal dynamic-range compression.

The voice coil itself is constructed of edge-wound rectangular aluminum wire, mounted on a rugged, laminated polyimide former. The complete assembly is low in mass and is fabricated using the most advanced epoxies, insulations and materials available.

Great care was taken in the selection of diaphragm materials and construction to ensure smooth, musical upper-bass reproduction and accurate low-frequency shock capability (punch). The cone has a moisture-repellent treatment, allowing it to be used in harsh and humid conditions. (Do not expose the cone to direct water or sunlight.)

The DL15X is a true high-fidelity woofer in every sense, being capable of high output, low distortion and solid bass response.

#### DIRECTIONAL CHARACTERISTICS

The directional characteristics of the DL15X in a 4.0-cubic-foot vented enclosure were measured in Electro-Voice's large anechoic chamber. The test signal was one-third-octave filtered pink noise centered at the frequencies indicated. A full spherical measurement system, which is completely compatible with the AcoustaCADD™ computer-aided design program, was used. All directional information was measured at 20 feet. Figure 8 illustrates the horizontal and vertical polar responses. Figure 6 shows the horizontal and vertical beamwidths. Beamwidth is the angle at which the horizontal and vertical polar responses have decreased in level by 6 dB when compared to the axial frequency response. Figure 7 illustrates the total directivity of the DL15X. The directivity factor  $R_1$  (Q) is the relative value, at a point, of the DL15X when compared to an ideal spherical response. The directivity index,  $D_1$ , is calculated by the formula:  $D_1 = 10 \log_{10} R_1$ .

#### TYPICAL AMPLIFIER SIZE

400-800 watts per woofer is the optimal amplifier size. Amplifiers of this size will allow maximum output with minimal risk of speaker damage when properly used. Smaller amplifiers can also be used with excellent results—the full capabilities of the speaker will simply not be used.

#### POWER-HANDLING TEST

Electro-Voice components and systems are manufactured to exacting standards, ensuring they will hold up, not only through the most rigorous of power tests, but also through continued use in arduous, real-life conditions. Two main test specifications are used: the "AES Recommended Practice for Specification of Loudspeaker Components Used in Professional Audio and Sound Reinforcement" (AES2-1984/ANSI S4.26-1984) and the "EIA Loudspeaker Power Rating Full Range" (ANSI/EIA RS-426-A 1980). Both of these specifications use noise spectrums which mimic typical music and test the thermal and mechanical capabilities of the components. Electro-Voice will support relevant additional standards as and when they become available. Extreme, in-house power tests, which push the performance boundaries of the components, are also performed and passed to ensure years of trouble-free service.

Specifically, the DL15X passes ANSI/EIA RS-426-A 1980 with the following values:

$$R_{SR} = 6.9 \text{ ohms } (1.15 \times R_E)$$

$$P_E(\text{max}) = 400 \text{ watts}$$

$$\text{Test voltage} = 52.5 \text{ volts rms,}$$

$$105.0 \text{ volts peak}$$

$$(+6 \text{ dB})$$

The DL15X passes AES2-1984/ANSI S4.26-1984 with the following values:

$$Z_{MIN} = 8.0 \text{ ohms at } 230 \text{ Hz}$$

$$P_E(\text{max}) = 400 \text{ watts}$$

$$\text{Test voltage} = 56.6 \text{ volts rms,}$$

$$113.2 \text{ volts peak}$$

$$(+6 \text{ dB})$$

Selected decade = 50-500 Hz

#### RESPONSE IN STANDARD BAFFLE

AES requires a large, planar baffle for this test, WHICH IS INTENDED TO SHOW SMOOTHNESS AND OFF-AXIS RESPONSE, NOT BASS RESPONSE. This has proven to be inconvenient and prohibitive, due to its size. Here, we have chosen our lab-standard, low-diffraction, 12-cubic-foot test enclosure, which will demonstrate the same characteristics as the AES standard baffle (see Figure 2). A smoothed swept-sine-wave input is used for this measurement to provide a more informative curve to the end user.

#### TYPICAL ENCLOSURES

The most extended bass, lowest distortion and best control is usually realized in properly designed vented enclosures. In such designs, the vent, or port, actually provides the lowest octave of output. The vent is driven to full acoustic output by a relatively small motion of the speaker cone itself, acting through the air contained within the enclosure. The excursion of the DL15X at these frequencies is much reduced compared to sealed or open-back enclosures, directly reducing harmonic distortion and the possibility of speaker bottoming. See Figure 11 for maximum potential output over the frequency range. Vented-enclosure recommendations follow, some incorporating low-frequency equalization. Thiele-Small parameters are provided so designers can tailor the response to suit their needs.

#### Normally Tuned Enclosures

See Figures 9A and 9B. The 6-cubic-foot enclosure is tuned to 35 Hz and has an extended response to below 40 Hz. The 4-foot enclosure has a response that "bumps up" from 60 to 110 Hz but has less extended low-bass output.

Also, Pro Sound Facts No. 7, "DL Series Woofers—Plans for Recommended Vented Enclosures and Small- and Large-Signal Performance for These Enclosures," is available from Electro-Voice at no charge. A wide variety of enclosure sizes and degree of low-frequency extension is described in this literature.

#### Step-Down Operation

The "step-down" mode approximates a  $B_6$  Thiele alignment. Step-down extends system low-frequency response by increasing amplifier power at certain frequencies instead of enclosure size. In step-down, the enclosure is tuned to a lower frequency than normal. This increases system output in the region of the new tuning frequency and reduces output slightly in the region of original tuning. The smoothly falling response which results can be equalized to

4. Teflon® is a registered trademark of DuPont.

provide a new system 3-dB-down point that is about 0.7 that of the original. To achieve a similar response extension without equalization would require an enclosure at least *twice* the size.

The equalization required is a second-order underdamped high-pass filter with a Q of 2 at the enclosure tuning frequency. This characteristic provides a boost of 6 dB at tuning and a 12-dB-per-octave roll-off below. The roll-off protects the woofer from overexcursion due to subpassband signals (see below). Note that the boost does not affect system instantaneous peak output, which is related only to the speaker's displacement ability and effective diaphragm area.

Pro Sound Facts No. 7, noted earlier, describes a number of step-down enclosures and the associated peak boost frequencies for the DL loudspeaker covered by this engineering data sheet. The Electro-Voice XEQ-2 and XEQ-3 active crossover/equalizers offer step-down equalization with a variety of peak-boost frequencies, appropriate for a broad range of specific systems. XEQ-2 and XEQ-3 engineering data sheets are available from Electro-Voice.

#### SUBPASSBAND SPEAKER PROTECTION

Below the enclosure tuning frequency, cone excursion increases rapidly. Since acoustic output is also falling rapidly, there is no utility in driving the system with signals much below tuning frequency. While such signals may be in the program material, they are often extraneous, such as a dropped microphone. The step-down equalization described in the Step-Down Operation section provides the required protection. If step-down equalization is not used, the Electro-Voice EX-24, XEQ-2 and XEQ-3 electronic crossover/equalizers can also provide subpassband protection. The 3-dB-down points are 30 Hz (EX-24 and XEQ-2) and 16 Hz or 32 Hz (XEQ-3).

Other high-pass filters are available, and one-third-octave equalizers can also be effective at providing the required protection.

#### USE IN MULTIPLES

Cone loudspeakers may be stacked for greater acoustic output and a narrower beamwidth. (It is assumed that all cones are operating in unison or in phase.)

At relatively low frequencies (below about 150 Hz for typical enclosures) stacking produces additional acoustic output without altering dispersion. When a common signal is applied, a 6-dB increase in maximum acoustic output is possible.

This increase occurs because the cones "mutually couple," acting as one cone with twice the area (therefore, twice the efficiency) and twice the power-handling capacity of a single cone. This mutual coupling occurs when the frequency is such that the center-to-center distance between the two woofer manifolds is less than about one-half wavelength.

#### MOUNTING

The DL15X may be front- or rear-mounted against either surface of its mounting flange

and requires a 353 mm (13.9 in.) diameter cutout and a 371 mm (14.6 in.) bolt circle. Normal fasteners up to 6 mm (1/4 in.) will fit through the eight holes in the frame. Front mounting is simplest using the optional SMH-1 speaker mounting kit.

#### ELECTRICAL CONNECTIONS

The DL15X is fitted with a pair of plated, frame-mounted connectors with color-coded ends. Electrical connection is made by pushing down, inserting wire completely through the rectangular slot and releasing pressure. One conductor of #9 stranded, #8 AWG solid, a pair of twisted #15 AWG stranded or a pair of #14 AWG solid conductors will fit.

#### AES RECOMMENDED PRACTICE

The DL15X's specifications conform to the "AES Recommended Practice for Specification of Components Used in Professional Audio and Sound Reinforcement" (AES2-1984/ANSI S4.26-1984). This recommended practice was developed over a number of years by consultants, manufacturers and government agencies from around the world, so that the detailed performance information required in professional applications could be provided in a unified format. The recommended practice has been published in the October, 1984, issue of the *Journal of the Audio Engineering Society* (vol. 26, pp. 771-780). Individual copies of the recommended practice are available from the Audio Engineering Society, 60 East 42nd Street, New York, New York 10165, USA. Also appearing in this issue is an article which comments on the recommended practice from an engineering point of view (C.A. Henriksen, "Engineering Justifications for Selected Portions of the AES Recommended Practice for Specification of Loudspeaker Components," pp. 763-769). The comments in this article will be particularly of interest to those not involved in the day-to-day design and testing of loudspeakers.

#### ARCHITECTS' AND ENGINEERS' SPECIFICATIONS

The low frequency woofer shall have a nominal diameter of 350 mm (15 in.), an overall depth of 165 mm (6.48 in.) and weigh less than 8.6 kg (19.6 lb). The frame shall be constructed of strong, deformation-resistant die-cast aluminum. The magnet assembly shall incorporate PROTEF™ protection, a TIR™ (Thermo Inductive Ring) and FDD™ (Flux Demodulation Device) to reduce inductive coupling and increase power handling. The cone and dust dome should withstand use in damp and humid conditions. The voice coil shall have a diameter of 63.5 mm (2.5 in.), a winding depth of 15.2 mm (0.6 in.) and be made of edge-wound aluminum ribbon. The voice-coil former shall be made of aerospace-grade polyimide laminate and bonded with high-temperature epoxy adhesives. The performance specification of a representative production unit shall be as follows: measured sensitivity (SPL at 1 m (3.3 ft) with 1 watt input, 100- to 800-Hz pink noise) shall be in excess of 98 dB. The reference efficiency shall be at least 4.63%. The usable response shall be 45 to 3,000 Hz, and the nominal impedance shall be 8 ohms. The EIA rated power shall be 400 watts. The low-frequency transducer shall be the Electro-Voice DL15X.

#### UNIFORM LIMITED WARRANTY

Electro-Voice products are guaranteed against malfunction due to defects in materials or workmanship for a specified period, as noted in the individual product-line statement(s) below, or in the individual product data sheet or owner's manual, beginning with the date of original purchase. If such malfunction occurs during the specified period, the product will be repaired or replaced (at our option) without charge. The product will be returned to the customer prepaid. Exclusions and Limitations: The Limited Warranty does not apply to: (a) exterior finish or appearance; (b) certain specific items described in the individual product-line statement(s) below, or in the individual product data sheet or owner's manual; (c) malfunction resulting from use or operation of the product other than as specified in the product data sheet or owner's manual; (d) malfunction resulting from misuse or abuse of the product; or (e) malfunction occurring at any time after repairs have been made to the product by anyone other than Electro-Voice or any of its authorized service representatives. **Obtaining Warranty Service:** To obtain warranty service, a customer must deliver the product, prepaid, to Electro-Voice or any of its authorized service representatives together with proof of purchase of the product in the form of a bill of sale or receipted invoice. A list of authorized service representatives is available from Electro-Voice at 600 Cecil Street, Buchanan, MI 49107 (616/695-6831 or 800/234-6831). **Incidental and Consequential Damages Excluded:** Product repair or replacement and return to the customer are the only remedies provided to the customer. Electro-Voice shall not be liable for any incidental or consequential damages including, without limitation, injury to persons or property or loss of use. Some states do not allow the exclusion or limitation of incidental or consequential damages so the above limitation or exclusion may not apply to you. **Other Rights:** This warranty gives you specific legal rights, and you may also have other rights which vary from state to state.

**Electro-Voice Speakers and Speaker Systems** are guaranteed against malfunction due to defects in materials or workmanship for a period of five (5) years from the date of original purchase. The Limited Warranty does not apply to burned voice coils or malfunctions such as cone and/or coil damage resulting from improperly designed enclosures. Electro-Voice active electronics associated with the speaker systems are guaranteed for three (3) years from the date of original purchase. Additional details are included in the Uniform Limited Warranty statement.

Service and repair address for this product: Electro-Voice, Inc., 600 Cecil Street, Buchanan, Michigan 49107 (616/695-6831 or 800/234-6831).

Specifications subject to change without notice.



**ELECTRO-VOICE** a MARK IV company **600 Cecil Street, Buchanan, Michigan 49107**

MANUFACTURING PLANTS AT ■ BUCHANAN, MI ■ NEWPORT, TN ■ SEVIERVILLE, TN ■ OKLAHOMA CITY, OK ■ GANANOQUE, ONT.  
© Electro-Voice, Inc. 1994 ■ Litho in U.S.A. Part Number 531999 — 9434